

1

Kit 5220

LEXUS ES-Series, 4-dr Sedan, 19-

ISO 11154-E

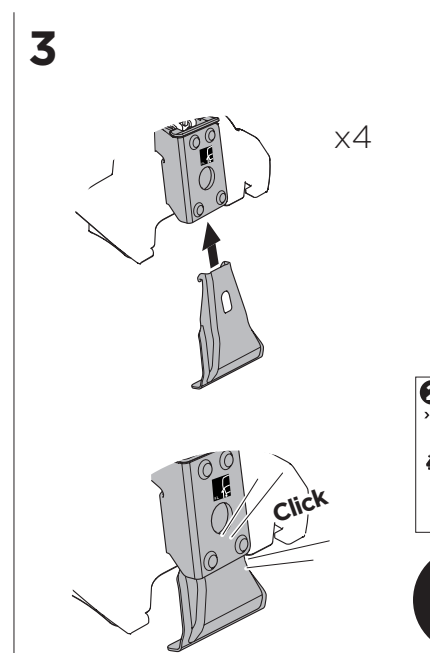
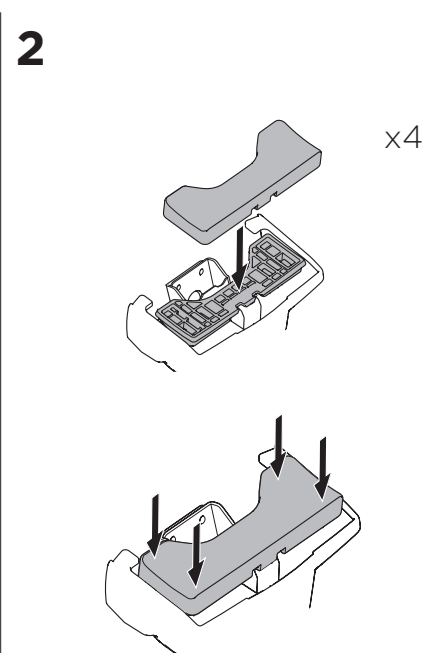
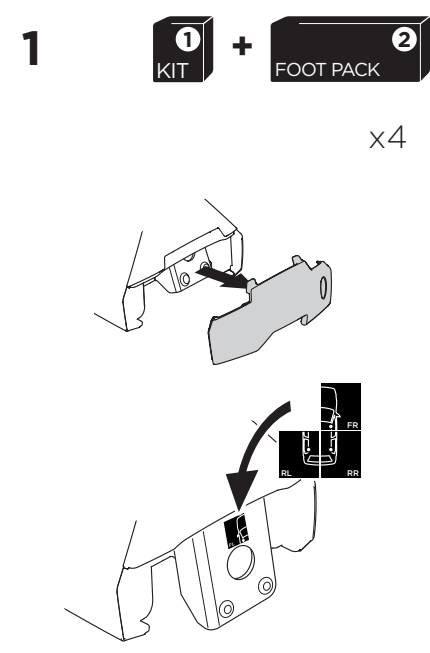
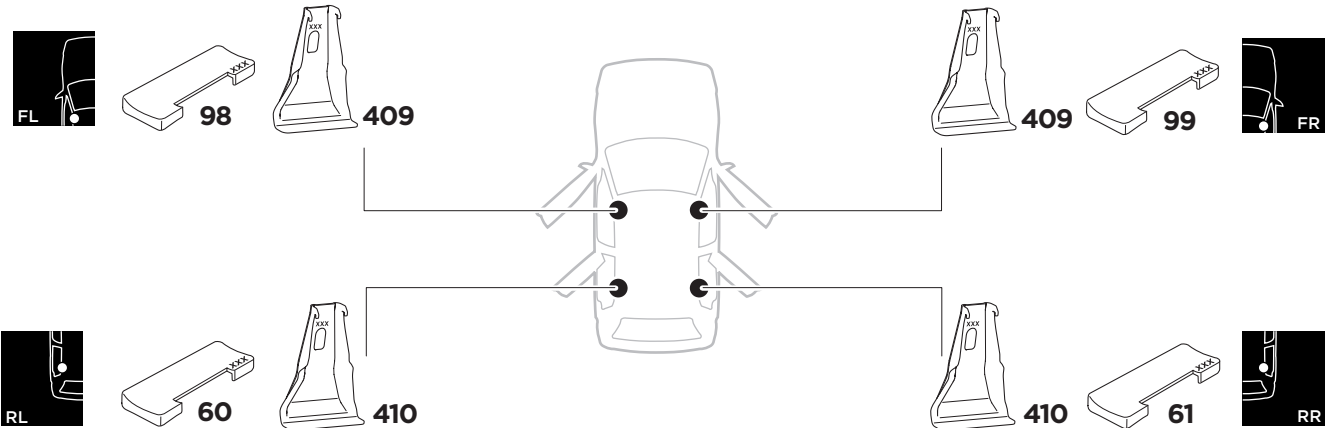
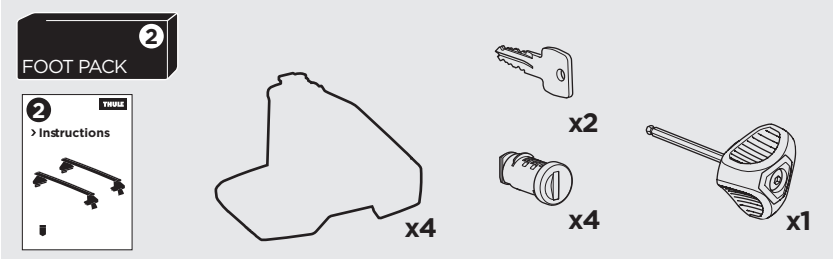
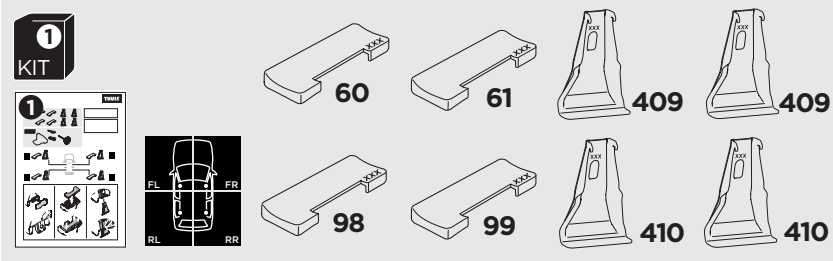



THULE WingBar Evo	THULE WingBar Edge	THULE WingBar	THULE SquareBar	Evo X (scale)	Edge X (scale)
LEXUS ES-Series, 4-dr Sedan, 19-				41,5	N

THULE ProBar	THULE SlideBar	X (mm/inch)		
LEXUS ES-Series, 4-dr Sedan, 19-		1066 mm / 42"		



THULE WingBar Evo	THULE WingBar Edge	THULE WingBar	THULE SquareBar	Evo Y (scale)	Edge Y (scale)
LEXUS ES-Series, 4-dr Sedan, 19-				36	G

THULE ProBar	THULE SlideBar	Y (mm/inch)		
LEXUS ES-Series, 4-dr Sedan, 19-		1011 mm / 39 3/4"		

	W (mm/inch)	Z (mm/inch)
LEXUS ES-Series, 4-dr Sedan, 19-	690 mm / 27 1/8"	200 mm / 7 7/8"

